

C92GPX2

Categorie fornuis	90x60 cm
N. of cavities with energy label	2
Cavity heat source	Elektriciteit
Type kookplaat	Gas
Type primaire oven	Thermogeventileerd
Type secundaire oven	Statisch
Reinigingssysteem primaire oven	Pyrolyse reiniging
EAN-code	8017709329723
Energie-efficiëntieklasse	A
Energie-efficiëntieklasse, tweede oven	A



Design









Design	Classici	Kleur	Inox
Series	Sinfonia	bedieningsknoppen	
Kleur	Inox	Display	Touch
Afwerking	Geborsteld inox	Aantal bedieningsknoppen	8
Design	Squadrato	Kleur serigrafie	Zwart
Deur	Met 2 horizontale stroken	Handgreep	Smeg Classici
Upstand	Ja	Kleur handgreep	Geborsteld inox
Type pottendragers	Gietijzeren pottendragers	Type glas	Eclipse zwart glas
Kleur kookplaat	Inox	Pootjes	Zilver
Afwerking bedieningspaneel	Inox finger friendly	Opbergruimte	Opbergvak met klep
Bedieningsknoppen	Smeg Classici	Logo	Assembled st/steel
		Positie logo	Strook onder de oven

Programma's / Functies

Aantal kookfuncties	9
---------------------	---

Traditionele bereidingsfuncties

 Statisch	 Geventileerd	 Circulatie (ventilator + circulaire)
 Turbo	 ECO	 Grote grill
 Ventilator + grote grill	 Onderwarmte	 Geventileerde onderwarmte





Reinigingsfuncties

 Pyrolyse

Programma's / Functies secundaire oven

Aantal kookfuncties	4
Onderwarmte + bovenwarmte	

Traditionele bereidingsfuncties, 2e oven

 Statisch	 Kleine grill	 Grote grill
 Onderwarmte		

Technische specificaties kookplaat

			
Totaal aantal kookzones	6		
Linksvoor - Gas - 2URP (dual) - 4.20 kW			
Linksachter - Gas - AUX - 1.00 kW			
Middenvoor - Gas - AUX - 1.00 kW			
Middenachter - Gas - SRD - 1.80 kW			
Rechtsvoor - Gas - SRD - 1.80 kW			
Rechtsachter - Gas - RP - 3.00 kW			
Type gasbranders	Standaard	Thermobeveiliging	Ja
Automatische vonkontsteking	Ja	Branderdeksels	Mat zwart geëmailleerd

Technische specificaties primaire oven

							
Aantal lampen	1	Aantal ruiten ovendeur	4				
Aantal ventilatoren	1	Aantal thermo-reflecterende ruiten	3				
Netto volume 1e oven	70 l	Veiligheidsthermostaat	Ja				
Bruto volume, oven 1	79 l						

Materiaal ovenruimte	Ever Clean emaille	Automatische uitschakeling verhogingselementen bij openen deur	Ja
Aantal kookniveaus	5		
Type ovenrekken	Metalen zijsteunen		
Type licht	Halogeen	Koelsysteem	Mantelkoeling
Vermogen lamp	40 W	Deurblokkering tijdens pyrolyse	Ja
Opties bereidingstijdprogrammering	Begin en eind	Afmetingen bruikbare interne ovenruimte (hxbxd)	360X460X425 mm
Automatische inschakeling verlichting bij openen deur	Ja	Temperatuurregeling	Elektro-mechanisch
Opening deur	Neerwaarts	Onderwarmte - vermogen	1200 W
Uitneembare ovendeur	Ja	Bovenwarmte - vermogen	1000 W
Volledig glazen binnendeur	Ja	Grill - vermogen	1700 W
Uitneembaar glas binnendeur	Ja	Grote vlakgrill - vermogen	2700 W
		Circulatie - vermogen	2000 W
		Grill type	Elektrisch

Opties primaire oven

Timer	Ja	Minimum temperatuur	50 °C
Geluidssignaal einde kooktijd	Ja	Maximum temperatuur	280 °C

Technische specificaties secundaire oven



Netto volume 2e oven	35 l	Aantal ruiten ovendeur	3
Bruto volume, oven 2	36 l	Aantal thermo-reflecterende ruiten	1
Materiaal ovenruimte	Ever Clean emaille	Veiligheidsthermostaat	Ja
Aantal kookniveaus	4	Koelsysteem	Mantelkoeling
Type ovenrekken	Metalen zijsteunen	Afmetingen bruikbare interne ovenruimte (hxbxd)	311x206x418 mm
Aantal lampen	1	Temperatuurregeling	Elektro-mechanisch
Type lamp	Gloeilamp	Onderwarmte - vermogen	700 W
Vermogen lamp	25 W	Bovenwarmte - vermogen	600 W
Opening deur	Neerwaarts	Grill - vermogen	1300 W
Uitneembare ovendeur	Ja	Grote vlakgrill - vermogen	1900 W
Volledig glazen binnendeur	Ja	Type grill	Elektrisch
Uitneembaar glas binnendeur	Ja		

Opties secundaire oven

Minimum temperatuur	50 °C	Maximum temperatuur	245 °C
---------------------	-------	---------------------	--------

Meegeleverde accessoires primaire oven en kookplaat



Ovenrooster met stop	1	Inzetrooster	1
Bakplaat (20 mm)	1	Telescopische geleiders, gedeeltelijk uitschuifbaar	1
Bakplaat (40 mm)	1		

Meegeleverde accessoires secundaire oven

Ovenrooster met stop	1	Inzetrooster	1
Bakplaat	1		

Elektrische aansluiting

Nominale aansluitwaarde	5100 W	Type of electric cable installed	Yes, Single phase
Stroom	23 A	Type stroomkabel	Yes, Double and Three Phase
Spanning	220-240 V	Frequentie	50/60 Hz
Spanning 2 (V)	380-415 V	Connection box	5 polig

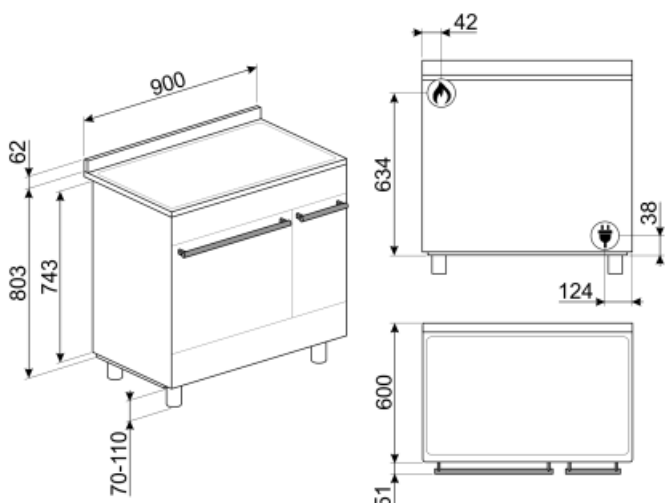

Not included accessories



TPKTR9

Stainless steel teppanyaki plate, suitable for Victoria TR9, Master and Sinfonia cookers

AIRFRY



GTP

Partially extractable telescopic guides (1 level), suitable for traditional ovens. Made in stainless steel, they guarantee stability and facilitate the smooth extraction of the trays.



PRTX

Ronde pizzasteen met handvaten, diameter 35 cm



BGTR9

Cast iron grill plate suitable for 90 cm Victoria, 60 and 90 cm Master and Sinfonia cookers



KITH900CPF9

Plinth, 90cm, three sides, black, suitable for CPF9 Portofino or Sinfony C9 cookers



BBQ

Dubbelzijdig



KITC9X9

Splashback, 90x75 cm, stainless steel, suitable for Master cookers



BN640

Enamelled tray suitable for 45cm and 60cm ovens. Depth 540 mm. Perfect for cooking and roasting meat and fish in sauces. Also ideal for experimenting with lighter and crunchy side dishes

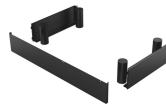

KITH95CPF9

Height extension kit with plinth, (950mm), three sides, black with feet, suitable for CPF9 Portofino and Sinfony C9 cookers



SFLK1

Child lock

KIT600C92PX

Cover strip for hob back side, suitable for 90cm Symphony cooker with pyro oven



BNP608T

Teflon bakplaat, 8mm diep



KITPBX

Height reduction feet (850mm), st/steel, for Sinfonia and Master cookers (845-856mm)



BN620-1

Enamelled tray suitable for 45cm and 60cm ovens. Depth 20 mm. Perfect for a wide range of savoury and sweet baking.



PALPZ

Pizzapallet inox met plooibaar handvat, 315x325 mm



GTT

Volledig uitschuifbare telescopische rails (1 niveau) voor traditionele ovens (SF-).







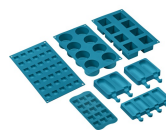





SMOLD

Set van 7 siliconen vormen voor ijsjes, pralines, ijsblokjes of porties. -60°C tot 230°C.



Symbols glossary (TT)

- A** A: Product drying performance, measured from A+++ to D / G depending on the product family
-  Air cooling system: to ensure a safe surface temperatures.
-  Quadruple glazed: Number of glazed doors.
-  Fingerprint proof stainless steel: Fingerprint proof stainless steel keeps stainless steel looking as good as new.
-  Ventilator met bovenste en onderste elementen: De elementen in combinatie met de ventilator zijn bedoeld om een meer gelijkmatige warmte te bieden, een methode die vergelijkbaar is met conventioneel koken, dus voorverwarmen is vereist. Het meest geschikt voor items die langzaam koken vereisen.
-  Alleen boven- en onder element: een traditionele kookmethode die het meest geschikt is voor losse items in het midden van de oven. de bovenkant van de oven zal altijd het heetst zijn. Ideaal voor gebraden vlees, fruitcake, brood etc.
-  Circulaire: De combinatie van de ventilator en het ronde element eromheen zorgt voor een hete lucht kookmethode. Dit biedt vele voordelen, waaronder geen voorverwarmen als de kooktijd meer dan 20 minuten bedraagt, geen smaakoverdracht bij het gelijktijdig bereiden van verschillende soorten voedsel, minder energie en kortere kooktijden. Geschikt voor alle soorten voedsel.
-  Heavy duty cast iron pan stands: for maximum stability and strength.
-  Triple glazed doors: Number of glazed doors.
-  Ever Clean Enamel: Ever Clean enamel is applied electrostatically, corner to corner and edge to edge to prevent cracking or cracks over time. It is a particular pyrolytic enamel, resistant to acids which, in addition to being pleasantly bright, promotes greater cleaning of the oven walls, thanks to its lower porosity. It is baked at over 850 ° C and slowly polymerized at a scientifically determined rate to ensure uniform depth and strength Ever Clean enamel creates an impeccable finish both on the inside of the oven and on the trays, making the surfaces of the oven incredibly easy to maintain over time as it reduces the adhesion of fat during cooking
-  Circogas: In gasovens verdeelt de ventilator de warmte snel en gelijkmatig over de ovenruimte, waardoor smaakoverdracht wordt vermeden bij het tegelijkertijd bereiden van een aantal verschillende gerechten. In elektrische ovens voltooit deze combinatie het koken van voedsel dat aan de oppervlakte klaar is, maar dat van binnen meer moet worden gekookt, zonder verder bruin te worden.
-  Alleen boven- en onder element: een traditionele kookmethode die het meest geschikt is voor losse items in het midden van de oven. de bovenkant van de oven zal altijd het heetst zijn. Ideaal voor gebraden vlees, fruitcake, brood etc.
-  Base: the heat comes only from the bottom of the cavity. The fan is not active. Ideal for sweet and savory pies, cobblers and pizzas. Designed to complete cooking and make food more crunchy This symbol in gas ovens indicates the gas burner.
-  De combinatie van de grill, de ventilator en onderwarmte is interessant voor het bereiden van kleine hoeveelheden.



Grill: Very intense heat coming only from above from a double heating element. The fan is not active. Provides excellent grilling and gratinating results. Used at the end of cooking, it gives a uniform browning to dishes.



Fan grill: very intense heat coming only from above from a double heating element The fan is active. It allows the optimal grilling of thickest meats. Ideal for large cuts of meat.



All glass inner door: All glass inner door, a single flat surface which is simple to keep clean.



Side lights: Two opposing side lights increase visibility inside the oven.



The oven cavity has 4 different cooking levels.



Telescopic rails: allow you to pull out the dish and check it without having to remove it from the oven entirely.



Ultra rapid burners: Powerful ultra rapid burners offer up to 5kw of power.



The capacity indicates the amount of usable space in the oven cavity in litres.



Half grill: For rapid cooking and browning of foods. Best results can be obtained by using the top shelf for small items, the lower shelves for larger ones, such as chops or sausages. For half grill heat is generated only at the centre of the element, so is ideal for smaller quantities.



Circulaire met bovenste en onderste elementen: door het gebruik van de ventilator met beide elementen kan voedsel snel en effectief worden gekookt, ideaal voor grote stukken vlees die grondig moeten worden gekookt. Het biedt een vergelijkbaar resultaat als rotisserie, waarbij de warmte rond het voedsel wordt verplaatst in plaats van het voedsel zelf te verplaatsen, waardoor elke maat of vorm kan worden gekookt.



The inner door glass: can be removed with a few quick movements for cleaning.



PYROLYSIS - AUTOMATIC CLEANING FUNCTION: the oven heats up to a temperature approaching 500 ° C and chars grease and food residues into a fine ash that can be easily wiped off with a damp cloth. At such a high temperature, the door locks automatically for safety, while the temperature of the door remains controlled so it is safe to touch User adjustable function based on the level of dirt present in the oven.



The oven cavity has 5 different cooking levels.



Electronic control: Allows you to maintain temperature inside the oven with the precision 2-3 ° C. This enables to cook meals that are very sensitive to temperature changes, such as cakes, souffles, puddings.



The capacity indicates the amount of usable space in the oven cavity in litres.