

CX91IMBL

Categorie fornuis	90x60 cm
N. of cavities with energy label	1
Cavity heat source	Elektriciteit
Type kookplaat	Inductie
Type primaire oven	Thermogeventileerd
Reinigingssysteem primaire oven	Vapor Clean reiniging
EAN-code	8017709343194
Energie-efficiëntieklasse	A











Design

			
Design	Classici	Aantal bedieningsknoppen	2
Series	Concerto	Kleur serigrafie	Wit
Kleur	Zwart	Bediening	Digi touch multi slider
Afwerking	Zwart	Kleur LED	Rood
Design	Standaard	Handgreep	Smeg Classici
Deur	Geheel glas	Kleur handgreep	Geborsteld inox
Kleur kookplaat	Black enamel	Type glas	Zwart
Afwerking bedieningspaneel	Gekleurd plaatstaal	Pootjes	Zwart
Bedieningsknoppen	Smeg Classici	Logo	In reliëf
Kleur bedieningsknoppen	Inox	Positie logo	Strook onder de oven
Display	Touch		

Programma's / Functies

Aantal kookfuncties	8
---------------------	---

Traditionele bereidingsfuncties

 Statisch	 Geventileerd	 Circulatie (ventilator + circulaire)
 ECO	 Kleine grill	 Grote grill
 Ventilator + grote grill	 Geventileerde onderwarmte	

Reinigingsfuncties

Katalyse reiniging

Opties kookplaat

			
Kinderbeveiliging	Ja	Beperkt vermogensverbruik	3000, 4500, 7400 W
ECO-Logic optie	Ja		

Technische specificaties kookplaat



Totaal aantal kookzones 4

Linksvoor - Inductie - enkel - 2.30 kW - Booster 3.00 kW - Ø 21.0 cm

Linksachter - Inductie - enkel - 1.30 kW - Booster 1.40 kW - Ø 18.0 cm

Rechtsachter - Inductie - maxi - 2.30 kW - Booster 3.00 kW - Ø 21.0 cm

Rechtsvoor - Inductie - enkel - 1.30 kW - Booster 1.40 kW - Ø 18.0 cm

Aantal kookzones met booster	4	Indicator minimaal te gebruiken diameter	Ja
Automatisch uitschakelen i.g.v. oververhitting	Ja	Indicator geselecteerde zone	Ja
Automatische aanpassing panafmeting	Ja		

Technische specificaties primaire oven



Aantal lampen	2	Uitneembaar glas binnendeur	Ja
Aantal ventilatoren	2	Aantal ruiten ovendeur	2
Netto volume 1e oven	115 l	Aantal thermo-reflecterende ruiten	1
Bruto volume, oven 1	129 l	Veiligheidsthermostaat	Ja
Materiaal ovenruimte	Ever Clean emaille	Koelsysteem	Mantelkoeling
Aantal kookniveaus	5	Afmetingen bruikbare interne ovenruimte (hxbxd)	371x724x418 mm
Type ovenrekken	Metalen zijsteunen		
Type licht	Halogeen		
Vermogen lamp	40 W		

Opties bereidingstijdprogrammering	Begin en eind	Temperatuurregeling	Elektro-mechanisch
Automatische inschakeling verlichting bij openen deur	Ja	Onderwarmte - vermogen	1700 W
Opening deur	Neerwaarts	Bovenwarmte - vermogen	1200 W
Uitneembare ovendeur	Ja	Grill - vermogen	1700 W
Volledig glazen binnendeur	Ja	Grote vlakgrill - vermogen	2900 W
		Circulatie - vermogen	2 x 1550 W
		Grill type	Elektrisch

Opties primaire oven

Timer	Ja	Minimum temperatuur	50 °C
Geluidssignaal einde kooktijd	Ja	Maximum temperatuur	260 °C

Meegeleverde accessoires primaire oven en kookplaat

Ovenrooster met stop	1	Bakplaat (20 mm)	1
-----------------------------	---	-------------------------	---

Elektrische aansluiting

Nominale aansluitwaarde	10600 W	Type of electric cable installed	Yes, Single phase
Stroom	46 A	Type stroomkabel	Yes, Double and Three Phase
Spanning	220-240 V	Frequentie	50/60 Hz
Spanning 2 (V)	380-415 V	Connection box	5 polig

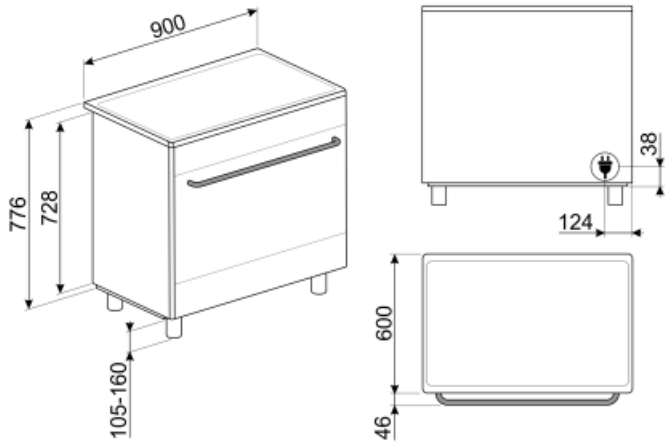

Not included accessories

AIRFRY9

Air fryer rack AIRFRY . Ideal for recreating traditional frying in the oven, but with fewer calories and less fat. It allows you to cook quickly and simply dishes such as French fries, fried vegetables and fish, ensuring perfect browning and crispiness.



AL90X9

Upstand suitable for 90cm Concerto cookers with gas hob and MF oven



GTP

Partially extractable telescopic guides (1 level), suitable for traditional ovens. Made in stainless steel, they guarantee stability and facilitate the smooth extraction of the trays.



AL90

Upstand suitable for 90 cm Concerto cookers



KIT600SNL-9

Cover strip for hob back side, depth 60mm, suitable for 90cm single oven Concerto cookers



KIT90X9-1

Splashback, stainless steel, 90cm, for Concerto cookers with single MF or gas oven



KITPDQ

Height reduction feet (850mm), stainless steel, for Concerto cookers (850-881mm)



PPX6090

Stainless steel grill plate suitable for 90 cm Concerto cookers



SFLK1

Child lock



PRTX

Ronde pizzasteen met handvaten, diameter 35 cm



PPR9

Refractory pizza stone without handles. Squared shaped stone: L64xH2,3xP37,5 cm Suitable also for gas ovens, to be put on the griddle.

BBQ9



KITH95

Height extension feet (950mm), stainless steel, suitable for Concerto cookers (911-966mm)



SCRP

Schraper voor inductie- en vitrokeramische kookplaten





PALPZ

Pizzapallet inox met plooibaar handvat,
315x325 mm



GTT



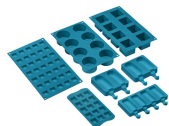













Volledig uitschuifbare telescopische
rails (1 niveau) voor traditionele ovens
(SF-).











SMOLD

Set van 7 siliconen vormen voor ijsjes,
pralines, ijsblokjes of porties. -60°C tot
230°C.

Symbols glossary (TT)

 <p>A: Product drying performance, measured from A+++ to D / G depending on the product family</p>	 <p>Power booster: option allows the zone to work at full power when very intense cooking is necessary.</p>
 <p>Sommige modellen zijn voorzien van een functie om het programma/de cyclus te blokkeren zodat het niet per ongeluk kan aangepast worden.</p>	 <p>Air cooling system: to ensure a safe surface temperatures.</p>
 <p>Double glazed doors: Number of glazed doors.</p>	 <p>ECO-logic: option allows you to restrict the power limit of the appliance real energy saving.</p>
 <p>Ever Clean Enamel: Ever Clean enamel is applied electrostatically, corner to corner and edge to edge to prevent cracking or cracks over time. It is a particular pyrolytic enamel, resistant to acids which, in addition to being pleasantly bright, promotes greater cleaning of the oven walls, thanks to its lower porosity. It is baked at over 850 ° C and slowly polymerized at a scientifically determined rate to ensure uniform depth and strength Ever Clean enamel creates an impeccable finish both on the inside of the oven and on the trays, making the surfaces of the oven incredibly easy to maintain over time as it reduces the adhesion of fat during cooking</p>	 <p>Circogas: In gasovens verdeelt de ventilator de warmte snel en gelijkmatig over de ovenruimte, waardoor smaakoverdracht wordt vermeden bij het tegelijkertijd bereiden van een aantal verschillende gerechten. In elektrische ovens voltooit deze combinatie het koken van voedsel dat aan de oppervlakte klaar is, maar dat van binnen meer moet worden gekookt, zonder verder bruin te worden.</p>
 <p>Ventilator met bovenste en onderste elementen: De elementen in combinatie met de ventilator zijn bedoeld om een meer gelijkmatige warmte te bieden, een methode die vergelijkbaar is met conventioneel koken, dus voorverwarmen is vereist. Het meest geschikt voor items die langzaam koken vereisen.</p>	 <p>Alleen boven- en onder element: een traditionele kookmethode die het meest geschikt is voor losse items in het midden van de oven. de bovenkant van de oven zal altijd het heetst zijn. Ideaal voor gebraden vlees, fruitcake, brood etc.</p>
 <p>Circulaire: De combinatie van de ventilator en het ronde element eromheen zorgt voor een hete lucht kookmethode. Dit biedt vele voordelen, waaronder geen voorverwarmen als de kooktijd meer dan 20 minuten bedraagt, geen smaakoverdracht bij het gelijktijdig bereiden van verschillende soorten voedsel, minder energie en kortere kooktijden. Geschikt voor alle soorten voedsel.</p>	 <p>De combinatie van de grill, de ventilator en onderwarmte is interessant voor het bereiden van kleine hoeveelheden.</p>
 <p>Grill: Very intense heat coming only from above from a double heating element. The fan is not active. Provides excellent grilling and gratinating results. Used at the end of cooking, it gives a uniform browning to dishes.</p>	 <p>Half grill: For rapid cooking and browning of foods. Best results can be obtained by using the top shelf for small items, the lower shelves for larger ones, such as chops or sausages. For half grill heat is generated only at the centre of the element, so is ideal for smaller quantities.</p>
 <p>Fan grill: very intense heat coming only from above from a double heating element The fan is active. It allows the optimal grilling of thickest meats. Ideal for large cuts of meat.</p>	 <p>Giant zone: The giant zone offers extra space and flexibility.</p>

-
-  Overheat protection: The safety system that automatically turns off the hob in case of overheating of the control unit.
 -  Induction: The work of these hobs is based on the principle of electromagnetic induction. The heat is generated directly in the bottom of the pan during its contact with the hob.
 -  All glass inner door: All glass inner door, a single flat surface which is simple to keep clean.
 -  The inner door glass: can be removed with a few quick movements for cleaning.
 -  Side lights: Two opposing side lights increase visibility inside the oven.
 -  The oven cavity has 5 different cooking levels.
 -  Vapor Clean: a simple cleaning function using steam to loosen deposits in the oven cavity.
 -  The capacity indicates the amount of usable space in the oven cavity in litres.
 -  Touch control