

FQ55FNDE



Product familie	Koelkast
Installatie	Vrijstaand
Categorie	Koel-vriescombinatie met 2 deuren en 2 schuiven
Referentie breedte	Meer dan 80 cm
Referentie hoogte	160 - 200 cm
No Frost systeem	Totaal No-Frost
Type koelen	Geventileerde koelkast, No Frost vriezer
Ontdooien	Automatisch ontdooien
Type scharnier	Standaard
EAN-code	8017709337650



Design



Design	Universeel	Materiaal zijwanden	Staal
Kleur	Zwart	Kleur zijkanten	Zwart
Afwerking	Glanzend	Logo	Geassembleerd
Design	Plat	Kleur profielen binnenzijde	Zilver
Materiaal deur	Plaatstaal	Kleur profielen laden	Zilver
Handgreep	Extern	Kleur profiel glazen leggers	Zilver
Type handgreep	Vast	Display	LED
Kleur handgreep	Zwart	Positie display	Esterno (su porta)
Kleur logo	Chroom		

Uitrusting koelkast



Aantal verstelbare leggers	3	Afdekplaat groentelade	Ja
Aantal groente-/fruitlades	2	Type afdekplaat groente-/fruitlade	Glas
Type verstelbare leggers	Glas	Binnenverlichting koelkast	Ja
Type afdekplaat groente-/fruitlade	Op telescopische geleiders	Type binnenverlichting koelkast	LED

Binnendeur koelkast

Aantal flessenhouders 2

Aantal binnendeurcompartimenten met transparante deksel	2	Flessenhouders met metalen steunen	Ja
Aantal verstelbare binnendeurcompartimenten	4		
Binnendeurcompartimenten met metalen steunen	Ja		

Overige features koelkast



Accessoires	Eierhouder	Ventilator	Ja
Natural Plus Blue Light	Ja	Anti bacteriële geurfilter	Ja
MultiFlow	Ja		

Uitrusting vriezer

Aantal lades	2
--------------	---

Overige features vriezer



Accessoires	1 ijsblokeshouder	Snel-vriescompartment	Ja
-------------	-------------------	-----------------------	----

Overige technische eigenschappen

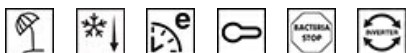

Display functies	Vakantiefunctie, Snel-vriesfunctie, Snel-koelfunctie, ECO, Kinderbeveiliging
Snel-vriestoets	Ja
Alarm open deur	Ja
Temperature Alarm	Ja
Anti bacteriële pakking	Ja
Type temperatuurcontrole	Elektronisch
Aantal compressoren	1
Type koelgas	R600a
Type compressor	Variabele toeren
Schuimmiddel	Cyclopentaan

Prestaties/Energie label - Reg. 2019



Annual energy consumption	302 KWh/jaar	Geluidsniveau	35 dB(A) re 1pW
Energie-efficiëntieklasse	E	Conserveringsduur zonder stroom	18 h







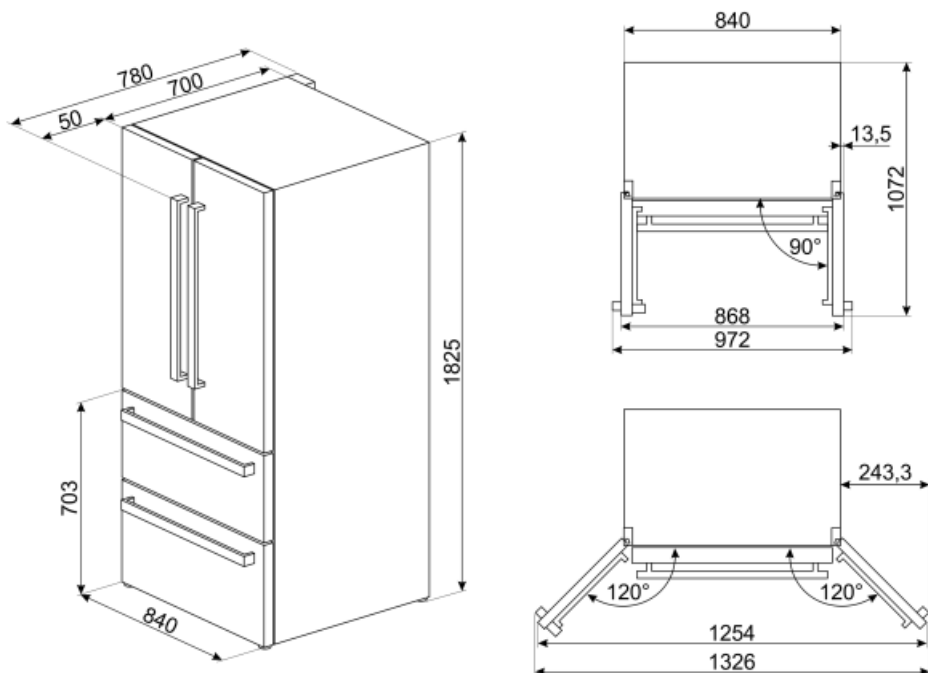







Emissieklasse voor akoestisch luchtgeluid	B	4 star - Freezing capacity	10.7 Kg/24h
Totaal netto volume	539 l	Klimaatklasse	SN, N, ST
Netto inhoud vriesgedeelte	152 l	EEl	100 %
Netto inhoud koelgedeeltes	387 l		

Elektrische aansluiting

Stekker	(F;E) Schuko	Spanning (V)	220-240 V
Nominale aansluitwaarde	160 W	Frequentie (Hz)	50 Hz
Stroom (A)	0,9 A	Lengte stroomkabel	240 cm



Symbols glossary (TT)

	The automatic defrost system works by automatically defrosting at regular intervals eliminating the need to defrost altogether.		Antibacterial treatment: antibacterial treatment to ensure better hygiene
	Sommige modellen zijn voorzien van een functie om het programma/de cyclus te blokkeren zodat het niet per ongeluk kan aangepast worden.		LED display: to show programmes, functions and options selected and the time to the end of the cycle.
	Economical mode: Analyzes fridge functioning during the activation and optimizes the operating cycle in order to reduce power consumption.		Geventileerd: een geforceerde verdeling van koude lucht in het koelkast compartiment, die een gelijke temperatuurverdeling verzekert in de koelkast.
	Fast freezing: The fast freezing function brings the temperature of the compartment down when activated a few hours prior to usage.		Power saving mode: The power saving mode allows you to disable the refrigerator and keep the freezer working.
	LED interior lighting: is a more energy efficient and long lasting way of illuminating the interior of the appliance.		De evolutie van Smeg vaatwassers naar meer intelligente en milieuvriendelijke modellen heeft ertoe geleid om de inverter technologie te gebruiken, die een significante energie- en geluidsbesparing met zich meebrengt.
	Air plus: keeps food fresher for longer.		Natural Plus Blue Light: Dit unieke Natural Plus Blue Light-systeem verlengt de bewaartijd van groenten en fruit
	No Frost: The No Frost and Frost free systems prevent ice from forming so that no defrosting is required.		Energie-efficiëntieklasse