

## FQ60BDE



Product familie	Koelkast
Installatie	Vrijstaand
Categorie	Koel-vriescombinatie met 4 deuren
Referentie breedte	Meer dan 80 cm
Referentie hoogte	160 - 200 cm
No Frost systeem	Totaal No-Frost
Type koelen	Dubbel koelsysteem
Ontdooien	Automatisch ontdooien
Type scharnier	Standaard
EAN-code	8017709337681



## Design



Design	Universeel	Kleur zijkanten	Wit
Kleur	Wit	Logo	Geassembleerd
Design	Plat	Kleur profielen binnenzijde	Zilver
Materiaal deur	Plaatstaal	Kleur profielen laden	Zilver
Handgreep	Extern	Kleur profiel glazen leggers	Zilver
Type handgreep	Vast	Display	LED
Kleur handgreep	Zilver	Positie display	Esterno (su porta)
Kleur logo	Chroom	Beschikbare kleuren	Inox, Zwart
Materiaal zijwanden	Staal		

## Uitrusting koelkast



Aantal verstelbare leggers	2	Type afdekplaat groente-/fruitlade	Glas
Aantal groente-/fruitlades	2	Aantal lampen	2
Type verstelbare leggers	Glas	Life Plus zone 0°C	Ja
Type afdekplaat groente-/fruitlade	Op telescopische geleiders	Binnenverlichting koelkast	Ja
Afdekplaat groentenlade	Ja	Type binnenverlichting koelkast	LED

## Binnendeur koelkast

Aantal binnendeurcompartimenten met transparante deksel	2	Aantal flessenhouders	2
Aantal verstelbare binnendeurcompartimenten	2		

## Overige features koelkast



Accessoires	Eierhouder	Ventilator	Ja
Natural Plus Blue Light	Ja	Anti bacteriële geurfilter	Ja
MultiFlow	Ja		

## Uitrusting vriezer

Aantal lades	3	Type leggers	Glas
Aantal legplanken	2		

## Overige features vriezer



Accessoires	2 ijsblokjeshouders	Snel-vriescompartment	Ja
-------------	---------------------	-----------------------	----

## Overige technische eigenschappen

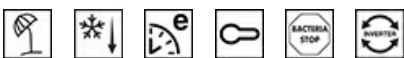

Display functies	Vakantiefunctie, Snel-vriesfunctie, Snel-koelfunctie, ECO, Kinderbeveiliging
Snel-vriestoets	Ja
Indicator (lampje) temperatuuralarm	Ja
Alarm open deur	Ja
Temperature Alarm	Ja
Anti bacteriële pakking	Ja
Type temperatuurcontrole	Elektronisch
Aantal compressoren	1
Type koelgas	R600a
Type compressor	Variabele toeren
Schuimmiddel	Cyclopentaan

## Prestaties/Energie label - Reg. 2019







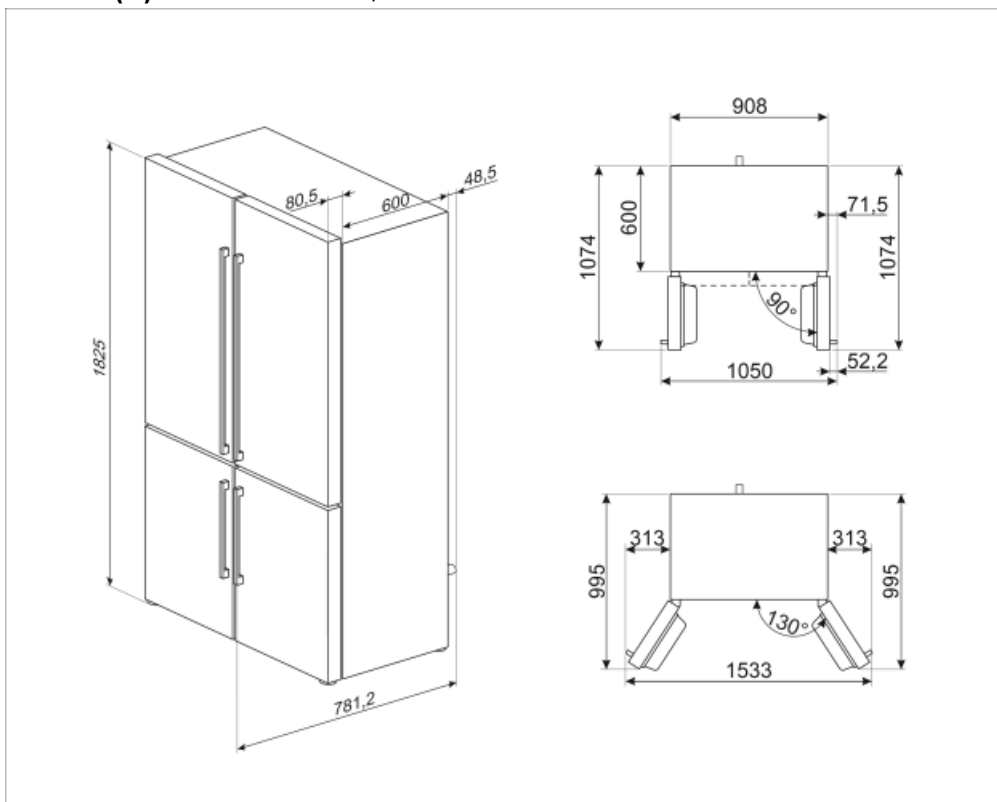







			
<b>Annual energy consumption</b>	406 KWh/jaar	<b>Geluidsniveau</b>	37 dB(A) re 1pW
<b>Energie-efficiëntieklasse</b>	E	<b>Conserveringsduur zonder stroom</b>	10 h
<b>Emissieklasse voor akoestisch luchtgeluid</b>	C	<b>4 star - Freezing capacity</b>	4.6 Kg/24h
<b>Totaal netto volume</b>	572 l	<b>4 star - Freezing capacity 1</b>	4.6 Kg/24h
<b>Netto inhoud vriesgedeelte</b>	196 l	<b>Klimaatklasse</b>	SN, N, ST, T
<b>Netto inhoud koelgedeeltes</b>	376 l	<b>EEl</b>	100 %

## Elektrische aansluiting

<b>Stekker</b>	(F;E) Schuko	<b>Spanning (V)</b>	230 V
<b>Nominale aansluitwaarde</b>	200 W	<b>Frequentie (Hz)</b>	50 Hz
<b>Stroom (A)</b>	0,8 A	<b>Lengte stroomkabel</b>	240 cm



## Symbols glossary (TT)

	The automatic defrost system works by automatically defrosting at regular intervals eliminating the need to defrost altogether.		Antibacterial treatment: antibacterial treatment to ensure better hygiene
	Sommige modellen zijn voorzien van een functie om het programma/de cyclus te blokkeren zodat het niet per ongeluk kan aangepast worden.		LED display: to show programmes, functions and options selected and the time to the end of the cycle.
	Economical mode: Analyzes fridge functioning during the activation and optimizes the operating cycle in order to reduce power consumption.		Geventileerd: een geforceerde verdeling van koude lucht in het koelkast compartiment, die een gelijke temperatuurverdeling verzekert in de koelkast.
	Fast freezing: The fast freezing function brings the temperature of the compartment down when activated a few hours prior to usage.		Power saving mode: The power saving mode allows you to disable the refrigerator and keep the freezer working.
	LED interior lighting: is a more energy efficient and long lasting way of illuminating the interior of the appliance.		Life Plus 0°C: The temperature in the Lifeplus compartments is kept at 0°C, which preserves fresh meat and fish longer.
	De evolutie van Smeg vaatwassers naar meer intelligente en milieuvriendelijke modellen heeft ertoe geleid om de inverter technologie te gebruiken, die een significante energie- en geluidsbesparing met zich meebrengt.		Air plus: keeps food fresher for longer.
	Natural Plus Blue Light: Dit unieke Natural Plus Blue Light-systeem verlengt de bewaartijd van groenten en fruit		Energie-efficiëntieklasse