

FQ60NDE



Product familie	Koelkast
Installatie	Vrijstaand
Categorie	Koel-vriescombinatie met 4 deuren
Referentie breedte	Meer dan 80 cm
Referentie hoogte	160 - 200 cm
No Frost systeem	Totaal No-Frost
Type koelen	Dubbel koelsysteem
Ontdooien	Automatisch ontdooien
Type scharnier	Standaard
EAN-code	8017709337674



Design



Design	Universeel	Kleur zijkanten	Zwart
Kleur	Zwart	Logo	Geassembleerd
Design	Plat	Kleur profielen binnenzijde	Zilver
Materiaal deur	Plaatstaal	Kleur profielen laden	Zilver
Handgreep	Extern	Kleur profiel glazen leggers	Zilver
Type handgreep	Vast	Display	LED
Kleur handgreep	Zwart	Positie display	Esterno (su porta)
Kleur logo	Chroom	Beschikbare kleuren	Inox, Wit
Materiaal zijwanden	Kunststof		

Uitrusting koelkast



Aantal verstelbare leggers	2	Type afdekplaat groente-/fruitlade	Glas
Aantal groente-/fruitlades	2	Aantal lampen	2
Type verstelbare leggers	Glas	Life Plus zone 0°C	Ja
Type afdekplaat groente-/fruitlade	Op telescopische geleiders	Binnenverlichting koelkast	Ja
Afdekplaat groentenlade	Ja	Type binnenverlichting koelkast	LED

Binnendeur koelkast

Aantal binnendeurcompartimenten met transparante deksel	2	Aantal flessenhouders	2
Aantal verstelbare binnendeurcompartimenten	2		

Overige features koelkast



Accessoires	Eierhouder	Ventilator	Ja
Natural Plus Blue Light	Ja	Anti bacteriële geurfilter	Ja
MultiFlow	Ja		

Uitrusting vriezer

Aantal lades	3	Type leggers	Glas
Aantal legplanken	2		

Overige features vriezer



Accessoires	2 ijsblokjeshouders	Snel-vriescompartiment	Ja
-------------	---------------------	------------------------	----

Overige technische eigenschappen

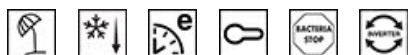

Display functies	Vakantiefunctie, Snel-vriesfunctie, Snel-koelfunctie, ECO, Kinderbeveiliging
Snel-vriestoets	Ja
Indicator (lampje) temperatuuralarm	Ja
Alarm open deur	Ja
Temperature Alarm	Ja
Anti bacteriële pakking	Ja
Type temperatuurcontrole	Elektronisch
Aantal compressoren	1
Type koelgas	R600a
Type compressor	Variabele toeren
Hoeveelheid koelmiddel	62 g
Schuimmiddel	Cyclopentaan

Prestaties/Energie label - Reg. 2019







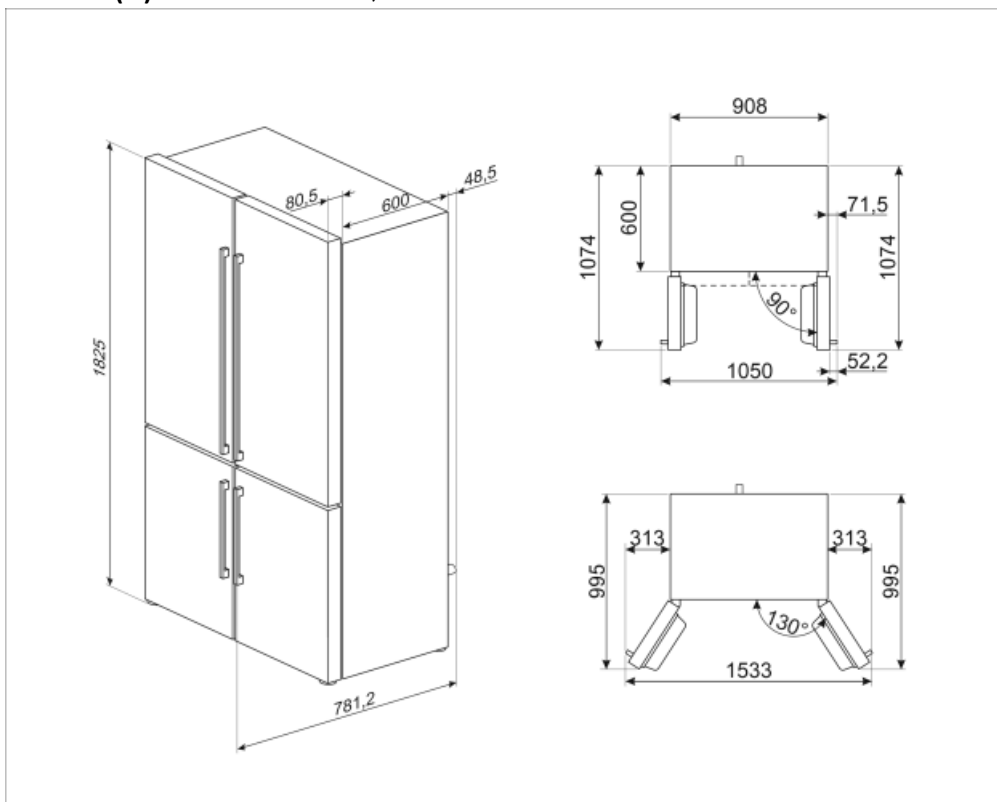







			
Annual energy consumption	338 KWh/jaar	Geluidsniveau	37 dB(A) re 1pW
Energie-efficiëntieklasse	E	Conserveringsduur zonder stroom	10 h
Emissieklasse voor akoestisch luchtgeluid	C	4 star - Freezing capacity	4.6 Kg/24h
Totaal netto volume	572 l	4 star - Freezing capacity 1	4.6 Kg/24h
Netto inhoud vriesgedeelte	196 l	Klimaatklasse	SN, N, ST, T
Netto inhoud koelgedeeltes	376 l	EEl	100 %

Elektrische aansluiting

Stekker	(F;E) Schuko	Spanning (V)	220-240 V
Nominale aansluitwaarde	200 W	Frequentie (Hz)	50 Hz
Stroom (A)	0,8 A	Lengte stroomkabel	240 cm



Symbols glossary (TT)

	The automatic defrost system works by automatically defrosting at regular intervals eliminating the need to defrost altogether.		Antibacterial treatment: antibacterial treatment to ensure better hygiene
	Sommige modellen zijn voorzien van een functie om het programma/de cyclus te blokkeren zodat het niet per ongeluk kan aangepast worden.		LED display: to show programmes, functions and options selected and the time to the end of the cycle.
	Economical mode: Analyzes fridge functioning during the activation and optimizes the operating cycle in order to reduce power consumption.		Geventileerd: een geforceerde verdeling van koude lucht in het koelkast compartiment, die een gelijke temperatuurverdeling verzekert in de koelkast.
	Fast freezing: The fast freezing function brings the temperature of the compartment down when activated a few hours prior to usage.		Power saving mode: The power saving mode allows you to disable the refrigerator and keep the freezer working.
	LED interior lighting: is a more energy efficient and long lasting way of illuminating the interior of the appliance.		Life Plus 0°C: The temperature in the Lifepus compartments is kept at 0°C, which preserves fresh meat and fish longer.
	De evolutie van Smeg vaatwassers naar meer intelligente en milieuvriendelijke modellen heeft ertoe geleid om de inverter technologie te gebruiken, die een significante energie- en geluidsbesparing met zich meebrengt.		Air plus: keeps food fresher for longer.
	Natural Plus Blue Light: Dit unieke Natural Plus Blue Light-systeem verlengt de bewaartijd van groenten en fruit		Energie-efficiëntieklasse