

SO4101M1B3

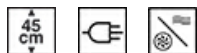

Categorie	45 cm
Product familie	Oven
Stroomvoorziening	Elektrisch
Warmtebron	Elektriciteit
Bereidingswijze	Combi-microgolf
Galileo technologie	Micro combi
EAN-code	8017709337292

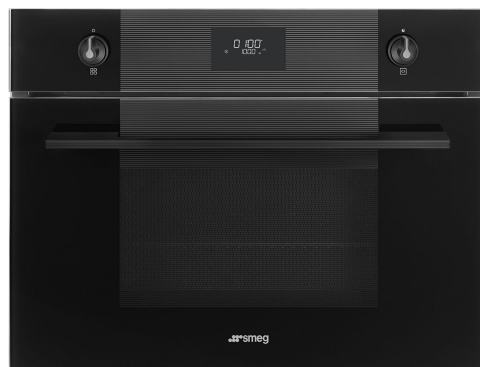

Design

Design	Linea	Type zeefdruk	Symbolen
Kleur	Zwart	Deur	Geheel glas
Afwerking	Glanzend	Handvat	Linea minimal
Design	Plat	Kleur handvat	Zwart
Materiaal	Glas	Logo	Geëts
Type glas	Clear1	Bedieningsknoppen	Linea
Kleur serigrafie	Grijs	Kleur bedieningsknoppen	Zwart

Bediening

			
Display	CompactScreen	Bediening	Bedieningsknoppen
Display	LCD	Aantal bedieningsknoppen	2

Programma's / Functies

Aantal kookfuncties	10
---------------------	----

Traditionele bereidingsfuncties

Statisch	Statisch + ventilator	Circulatie (ventilator + circulaire)
Turbo: ventilator + circulaire + statisch	ECO	Grote grill

Bereidingsfuncties met microgolven

Microgolven	Microgolf + boven- en onderwarmte + ventilator	Microgolf + circulaire + ventilator
Microgolf + grill		

Overige functies

Ontdooien op tijd

Opties



Tijdsinstelling	Automatische in- en uitschakeling	Andere opties	Warmhoudfunctie, Eco light
Timer	Ja	Showroom demo optie	Ja
Timer	1	Snel voorverwarmen	Ja
Kinderbeveiliging	Ja		

Technische specificaties



Minimum temperatuur	30 °C	Opening deur	Standaard opening
Maximum temperatuur	250 °C	Deur	Temperatuur gecontroleerde deur
Aantal kookniveaus	2	Totaal aantal ruiten	3
Aantal lampen	1	Automatische uitschakeling microgolf bij openen deur	Ja
Type lamp	Halogeen	Chimney	Fixed
Vermogen lamp	40 W	Koelsysteem	Mantelkoeling
Verlichting bij opening deur	Ja		

Onderwarmte - vermogen	1000 W	Koelleiding	Enkel
Grill - vermogen	1750 W	Afmetingen bruikbare interne ovenruimte (hxbxd)	211x462x401 mm
Circulatie - vermogen	1400 W	Temperatuurcontrole	Elektronisch
Warmte onderbroken bij openen deur	Ja	Materiaal ovenruimte	Ever Clean emaille
		Veiligheidsscherm microgolfdeur	Ja

Prestaties / energielabel



Netto volume	40 l	Effectief vermogen microgolf	850 W
Aantal ovens	1		

Meegeleverde accessoires







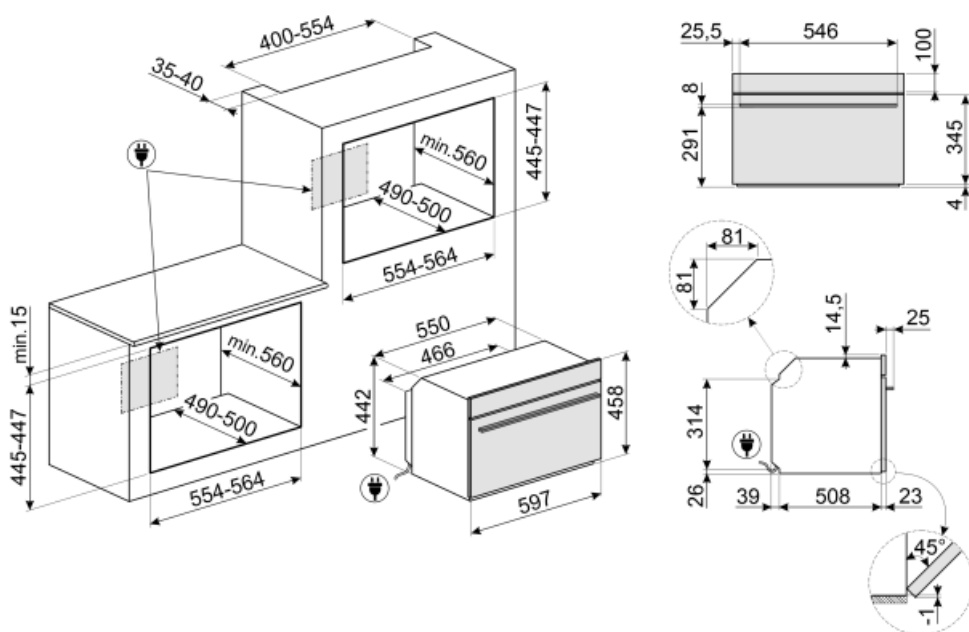







Ovenrooster met stop	1	Glazen ovenplaat	1
Inzetrooster	1		















Elektrische aansluiting

Spanning	220-240 V	Frequentie	50 Hz
Stroom	14 A	Lengte voedingskabel	150 cm
Nominale aansluitwaarde	3100 W		



Symbols glossary (TT)

 <p>Sommige modellen zijn voorzien van een functie om het programma/de cyclus te blokkeren zodat het niet per ongeluk kan aangepast worden.</p>	 <p>Combination microwave: This oven allows to combine two different ways of cooking (Traditional with microwaves). Combined ovens increase cooking opportunities, while providing maximum flexibility of household appliances.</p>
 <p>Air cooling system: to ensure a safe surface temperatures.</p>	 <p>Defrost by time: Manual defrost function. At the end of the set duration, the function stops.</p>
 <p>Triple glazed doors: Number of glazed doors.</p>	 <p>Automatic lighting deactivation: For greater energy savings, the lighting turns off automatically after one minute from the start of cooking. The option can be disabled via the settings menu. In this case the light will remain on for the entire duration of cooking.</p>
 <p>Elektrische aansluiting</p>	 <p>Ever Clean Enamel: Ever Clean enamel is applied electrostatically, corner to corner and edge to edge to prevent cracking or cracks over time. It is a particular pyrolytic enamel, resistant to acids which, in addition to being pleasantly bright, promotes greater cleaning of the oven walls, thanks to its lower porosity. It is baked at over 850 ° C and slowly polymerized at a scientifically determined rate to ensure uniform depth and strength. Ever Clean enamel creates an impeccable finish both on the inside of the oven and on the trays, making the surfaces of the oven incredibly easy to maintain over time as it reduces the adhesion of fat during cooking.</p>
 <p>Ventilator met bovenste en onderste elementen: De elementen in combinatie met de ventilator zijn bedoeld om een meer gelijkmatige warmte te bieden, een methode die vergelijkbaar is met conventioneel koken, dus voorverwarmen is vereist. Het meest geschikt voor items die langzaam koken vereisen.</p>	 <p>Alleen boven- en onder element: een traditionele kookmethode die het meest geschikt is voor losse items in het midden van de oven. De bovenkant van de oven zal altijd het heetst zijn. Ideaal voor gebraden vlees, fruitcake, brood etc.</p>
 <p>Circulaire: De combinatie van de ventilator en het ronde element eromheen zorgt voor een hete lucht kookmethode. Dit biedt vele voordelen, waaronder geen voorverwarmen als de kooktijd meer dan 20 minuten bedraagt, geen smaakoverdracht bij het gelijktijdig bereiden van verschillende soorten voedsel, minder energie en kortere kooktijden. Geschikt voor alle soorten voedsel.</p>	 <p>De combinatie van de grill, de ventilator en onderwarmte is interessant voor het bereiden van kleine hoeveelheden.</p>
 <p>Grill: Very intense heat coming only from above from a double heating element. The fan is not active. Provides excellent grilling and gratinating results. Used at the end of cooking, it gives a uniform browning to dishes.</p>	 <p>Microwave: Penetrating straight into the food, microwaves cook very quickly and with considerable energy savings. Suitable for cooking without fat, they are also able to thaw and heat food without altering its original appearance and aroma. The microwave function can also be combined with conventional functions with all the resulting advantages. Ideal for all types of food.</p>

-  Cooking with the simultaneous use of the heating element in combination with fan and microwave supply.
-  Fan combined with traditional cooking, where heat is generated from above and below, provides uniform heat. Adding the microwave function allows the same cooking results in less time.
-  45 cm
Compacte toestellen met een hoogte van 45 cm - perfecte oplossing om te voldoen aan de functionele eisen van keukensets met een kleine hoogte. Verkrijgbaar in verschillende soorten en in verschillende stijlen.
-  Illuminated controls: are a safety device to alert the user that the appliance is on as well as being a stunning design feature.
-  Rapid preheating: cooking is preceded by the preheating phase which allows the cooking compartment to reach the set temperature. This option reduces the time by up to 50%.
-  Electronic control: Allows you to maintain temperature inside the oven with the precision 2-3 ° C. This enables to cook meals that are very sensitive to temperature changes, such as cakes, souffles, puddings.
-  40 lt
The capacity indicates the amount of usable space in the oven cavity in litres.
-  Microwave + grill element: The use of the grill results in a perfect browning of the surface of the food. The action of microwaves allows instead of cooking in a short time the internal part of the food.
-  Circulaire met bovenste en onderste elementen: door het gebruik van de ventilator met beide elementen kan voedsel snel en effectief worden gekookt, ideaal voor grote stukken vlees die grondig moeten worden gekookt. Het biedt een vergelijkbaar resultaat als rotisserie, waarbij de warmte rond het voedsel wordt verplaatst in plaats van het voedsel zelf te verplaatsen, waardoor elke maat of vorm kan worden gekookt.
-  Met deze functie kan u bereidingen warmhouden zodat het eten niet meteen afkoelt
-  Side lights: Two opposing side lights increase visibility inside the oven.
-  2
The oven cavity has 2 different cooking levels.
-  Tilting grill: the tilting grill can be easily unhooked to move the heating element and clean the roof of the appliance in one simple step.
-  COMPACT screen
COMPACTscreen display + bedieningsknoppen