

C9IMN2

Categorie fornuis	90x60 cm
N. of cavities with energy label	1
Cavity heat source	Elektriciteit
Type kookplaat	Inductie
Type primaire oven	Thermogeventileerd
Reinigingsysteem primaire oven	Vapor Clean reiniging
EAN-code	8017709336233
Energie-efficiëntieklasse	A



Design

			
Design	Classici	Aantal bedieningsknoppen	7
Series	Sinfonia	Kleur serigrafie	Zilver
Kleur	Zwart	Bediening	Bedieningsknoppen
Afwerking	Mat zwart	Kleur LED	Rood
Design	Squadrato	Handgreep	Smeg Classici
Deur	Met 2 horizontale stroken	Kleur handgreep	Zwart
Kleur kookplaat	Black enamel	Type glas	Eclipse zwart glas
Afwerking bedieningspaneel	Gekleurd plaatstaal	Pootjes	Zwart
Bedieningsknoppen	Smeg Classici	Opbergruimte	Opbergvak met klep
Kleur bedieningsknoppen	Zwart	Logo	Assembled st/steel
Display	Touch	Positie logo	Strook onder de oven

Programma's / Functies

Aantal kookfuncties	9
---------------------	---

Traditionele bereidingsfuncties

Statisch	Geventileerd	Circulatie (ventilator + circulaire)
ECO	Kleine grill	Grote grill
Ventilator + grote grill	Onderwarmte	Geventileerde onderwarmte

Reinigingsfuncties

Vapor Clean reiniging

Overige functies

Ontdooien op tijd

Opties kookplaat

Kinderbeveiliging	Ja	Beperkt vermogensverbruik	3700, 4800, 7400 W
ECO-Logic optie	Ja	Multizone optie	Ja

Technische specificaties kookplaat



Totaal aantal kookzones 5

Linksvoor - Inductie - Multizone - 2.10 kW - Booster 2.30 kW - 21.0x19.0 cm

Linksachter - Inductie - Multizone - 1.60 kW - Booster 1.85 kW - 21.0x19.0 cm

Midden - Inductie - enkel - 2.30 kW - Booster 3.00 kW - Ø 27.0 cm

Rechtsachter - Inductie - enkel - 1.20 kW - Booster 1.40 kW - Ø 18.0 cm

Rechtsvoor - Inductie - enkel - 2.30 kW - Booster 3.00 kW - Ø 21.0 cm

Aantal kookzones met booster	5	Indicator minimaal te gebruiken diameter	Ja
Automatisch uitschakelen i.g.v. oververhitting	Ja	Indicator geselecteerde zone	Ja
Automatische aanpassing panafmeting	Ja	Indicator (lampje) restwarmte	Ja

Technische specificaties primaire oven



Aantal lampen 2

Aantal ventilatoren	2	Uitneembaar glas binnendeur	Ja
Netto volume 1e oven	115 l	Aantal ruiten ovendeur	3
Bruto volume, oven 1	129 l	Aantal thermo-reflecterende ruiten	2
Materiaal ovenruimte	Ever Clean emaille	Veiligheidsthermostaat	Ja
Aantal kookniveaus	5	Koelsysteem	Mantelkoeling
Type ovenrekken	Metalen zijsteunen	Afmetingen bruikbare interne ovenruimte (hxbxd)	371x724x418 mm
Type licht	Halogeen	Temperatuurregeling	Elektro-mechanisch
Vermogen lamp	40 W	Onderwarmte - vermogen	1700 W
Opties bereidingstijdprogrammering	Begin en eind	Bovenwarmte - vermogen	1200 W
Automatische inschakeling verlichting bij openen deur	Ja	Grill - vermogen	1700 W
Opening deur	Neerwaarts	Grote vlakgrill - vermogen	2900 W
Uitneembare ovendeur	Ja	Circulatie - vermogen	2 x 1550 W
Volledig glazen binnendeur	Ja	Grill type	Elektrisch

Opties primaire oven

Timer	Ja	Minimum temperatuur	50 °C
Geluidssignaal einde kooktijd	Ja	Maximum temperatuur	260 °C

Meegeleverde accessoires primaire oven en kookplaat

Ovenrooster met stop	1	Inzetrooster	1
Bakplaat (20 mm)	1	Temperatuursonde	1
Bakplaat (40 mm)	1		

Elektrische aansluiting

Nominale aansluitwaarde	10600 W	Spanning 2 (V)	380-415 V
Stroom	46 A	Frequentie	50/60 Hz
Spanning	220-240 V	Connection box	5 polig

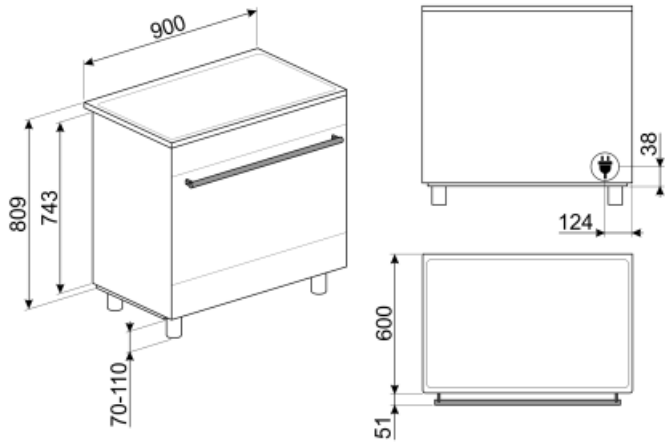

Not included accessories

AIRFRY9

Air fryer rack AIRFRY . Ideal for recreating traditional frying in the oven, but with fewer calories and less fat. It allows you to cook quickly and simply dishes such as French fries, fried vegetables and fish, ensuring perfect browning and crispiness.



SFLK1

Child lock



PRTX

Ronde pizzasteen met handvaten, diameter 35 cm



PPR9

Refractory pizza stone without handles. Squared shaped stone: L64xH2,3xP37,5 cm Suitable also for gas ovens, to be put on the griddle.



BBQ9



SCRP

Schraper voor inductie- en vitrokeramische kookplaten



TPKPLATE

Universal plate for induction, gas, ceramic and electric hobs. Non-stick surface ideal for cooking fish, eggs and vegetables. Dimensions: 410 X 240 mm.



KITH95MN

GTP

Partially extractable telescopic guides (1 level), suitable for traditional ovens. Made in stainless steel, they guarantee stability and facilitate the smooth extraction of the trays.



GRILLPLATE

Universal griddle for induction, gas, ceramic and electric hobs. Non-stick surface ideal for cooking meat, cheese and vegetables. Dimensions: 410 x 240 mm.



KITPBX

Height reduction feet (850mm), st/steel, for Sinfonia and Master cookers (845-856mm)



KITSB9MB



BBQ

Dubbelzijdig



KITC9X9-1

Splashback kit, st/steel, 90cm, suitable for Portofino Multifunction, Master and Sinfonia cookers

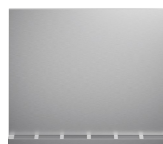



PALPZ

Pizzapallet inox met plooibaar handvat,
315x325 mm

KITC9X9

Splashback, 90x75 cm, stainless steel,
suitable for Master cookers



GTT



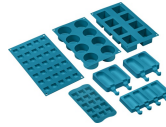













Volledig uitschuifbare telescopische rails
(1 niveau) voor traditionele ovens (SF-).













SMOLD

Set van 7 siliconen vormen voor ijsjes,
pralines, ijsblokjes of porties. -60°C tot
230°C.

Symbols glossary (TT)

 <p>Power booster: option allows the zone to work at full power when very intense cooking is necessary.</p>	 <p>Sommige modellen zijn voorzien van een functie om het programma/de cyclus te blokkeren zodat het niet per ongeluk kan aangepast worden.</p>
 <p>Knobs control</p>	 <p>Air cooling system: to ensure a safe surface temperatures.</p>
 <p>Defrost by time: Manual defrost function. At the end of the set duration, the function stops.</p>	 <p>Triple glazed doors: Number of glazed doors.</p>
 <p>ECO-logic: option allows you to restrict the power limit of the appliance real energy saving.</p>	 <p>A: Product drying performance, measured from A+++ to D / G depending on the product family</p>
 <p>Ever Clean Enamel: Ever Clean enamel is applied electrostatically, corner to corner and edge to edge to prevent cracking or cracks over time. It is a particular pyrolytic enamel, resistant to acids which, in addition to being pleasantly bright, promotes greater cleaning of the oven walls, thanks to its lower porosity. It is baked at over 850 ° C and slowly polymerized at a scientifically determined rate to ensure uniform depth and strength Ever Clean enamel creates an impeccable finish both on the inside of the oven and on the trays, making the surfaces of the oven incredibly easy to maintain over time as it reduces the adhesion of fat during cooking</p>	 <p>Circogas: In gasovens verdeelt de ventilator de warmte snel en gelijkmatig over de ovenruimte, waardoor smaakoverdracht wordt vermeden bij het tegelijkertijd bereiden van een aantal verschillende gerechten. In elektrische ovens voltooit deze combinatie het koken van voedsel dat aan de oppervlakte klaar is, maar dat van binnen meer moet worden gekookt, zonder verder bruin te worden.</p>
 <p>Ventilator met bovenste en onderste elementen: De elementen in combinatie met de ventilator zijn bedoeld om een meer gelijkmatige warmte te bieden, een methode die vergelijkbaar is met conventioneel koken, dus voorverwarmen is vereist. Het meest geschikt voor items die langzaam koken vereisen.</p>	 <p>Alleen boven- en onder element: een traditionele kookmethode die het meest geschikt is voor losse items in het midden van de oven. de bovenkant van de oven zal altijd het heetst zijn. Ideaal voor gebraden vlees, fruitcake, brood etc.</p>
 <p>Base: the heat comes only from the bottom of the cavity. The fan is not active. Ideal for sweet and savory pies, cobblers and pizzas. Designed to complete cooking and make food more crunchy This symbol in gas ovens indicates the gas burner.</p>	 <p>Circulaire: De combinatie van de ventilator en het ronde element eromheen zorgt voor een hete lucht kookmethode. Dit biedt vele voordelen, waaronder geen voorverwarmen als de kooktijd meer dan 20 minuten bedraagt, geen smaakoverdracht bij het gelijktijdig bereiden van verschillende soorten voedsel, minder energie en kortere kooktijden. Geschikt voor alle soorten voedsel.</p>
 <p>De combinatie van de grill, de ventilator en onderwarmte is interessant voor het bereiden van kleine hoeveelheden.</p>	 <p>Grill: Very intense heat coming only from above from a double heating element. The fan is not active. Provides excellent grilling and gratinating results. Used at the end of cooking, it gives a uniform browning to dishes.</p>

-
-  Half grill: For rapid cooking and browning of foods. Best results can be obtained by using the top shelf for small items, the lower shelves for larger ones, such as chops or sausages. For half grill heat is generated only at the centre of the element, so is ideal for smaller quantities.
 -  Overheat protection: The safety system that automatically turns off the hob in case of overheating of the control unit.
 -  All glass inner door: All glass inner door, a single flat surface which is simple to keep clean.
 -  Side lights: Two opposing side lights increase visibility inside the oven.
 -  The oven cavity has 5 different cooking levels.
 -  The capacity indicates the amount of usable space in the oven cavity in litres.
 -  Fan grill: very intense heat coming only from above from a double heating element The fan is active. It allows the optimal grilling of thickest meats. Ideal for large cuts of meat.
 -  Induction: The work of these hobs is based on the principle of electromagnetic induction. The heat is generated directly in the bottom of the pan during its contact with the hob.
 -  The inner door glass: can be removed with a few quick movements for cleaning.
 -  Indication of residual heat: After the glass ceramic hob is switched off the residual heat indicator shows which of the heating zones still remains hot. When the temperature drops below 60 ° C, the indicator goes out.
 -  Vapor Clean: a simple cleaning function using steam to loosen deposits in the oven cavity.